

Work happily



V1.0

naggura'swop

naggura.com

Our products

 **Podiatry**

S503WHITE S503GREY



The Swop 503 is a 3-engine podiatry bed of optimum stability and ultra-compact frame.

Wood, Metal or Pmma

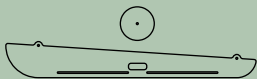

Collections

Nordic
METAL

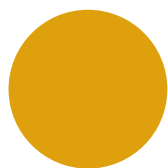

Yellow

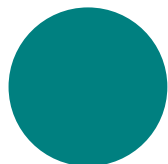

Blue

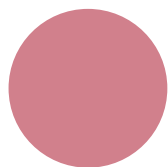

Pink

Foll
METAL



Ash

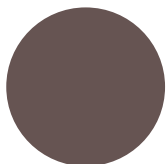

Clay

Iron
METAL

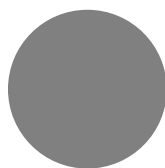

Inox

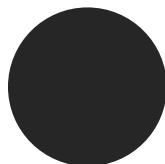

Black

Om
WOOD



Oak



Wenge

Techno
PMMA



Fluor

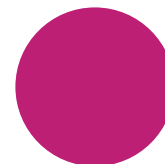

Fuxia

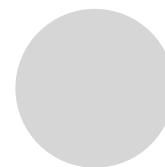

Ice

S503



Dimensions

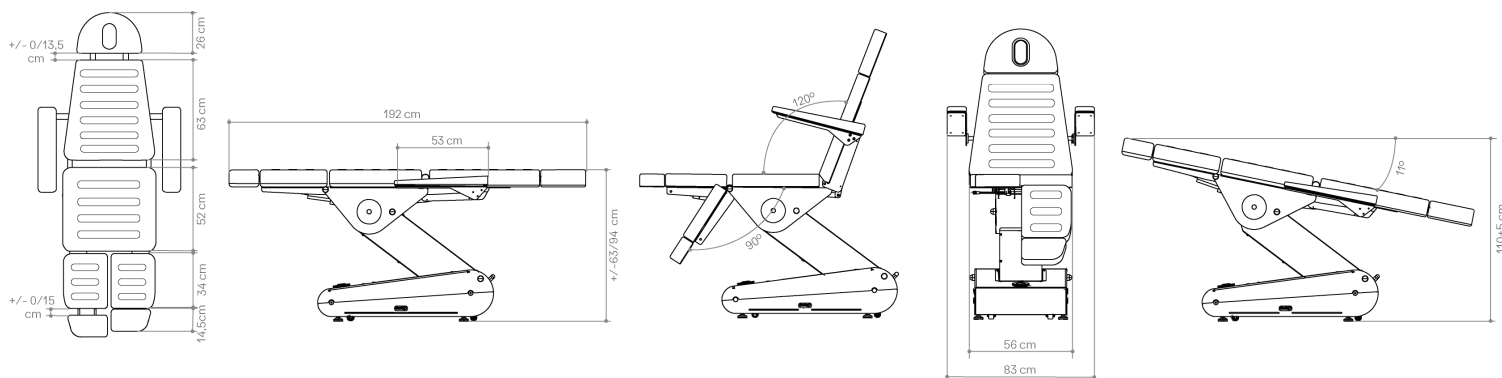

General Specifications

MOTORS
3 engines

DIMENSIONS (LENGTH X WIDTH)
192 x 83 cm

HEIGHT (MIN. AND MAX.)
63/94 cm

WEIGHT
105 kg

THICKNESS
10 cm

DENSITY
30 kg/m³

LIFTING CAPACITY
175 kg

OPERATION
**Hand controller (included)/
Foot controller (optional)**

POWER SUPPLY
230 V - 50/60 Hz

MAX. INTENSITY
2 A

ELECTRIC MOTOR
6.000 N

CUSHION

100% Vinyl-compound

Permablock 3 advanced vinyl protection (against germs, abrasion), UV resistant, superior abrasion 300K Grey colour

Permaguard advanced vinyl protection (against germs and stains), UV resistant, abrasion 100K White colour